



Benner-Nawman, Inc.

3450 Sabin Brown Road • Wickenburg, AZ 85390

(800) 992-3833 • (928) 684-2813 • www.bnproducts.com

Specification Sheet

Part #
BN14155W-UL

This Cabinet Measures:
14³/₄" Wide x 15" Tall x 5³/₄" Deep

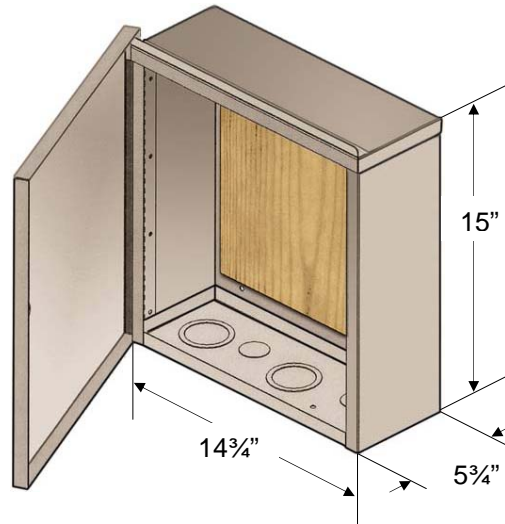

Features & Info:

- Includes 2 knockouts 2" - 2¹/₂" (for 1³/₄" - 2¹/₄" conduit) & 3 knockouts 1³/₈" (for 1¹/₄" conduit)
See Chart Below
- Includes a ³/₄" plywood backboard & 4-position, #4-14 wire ground bar mounted inside
- Made of 16-gauge(door) & 18-gauge(body), zinc-coated steel (powder coat tan finish)
- Optional brackets are available for recessed application (*shown on right*)
- Reinforced hinged lid with 7/16" recessed hex latch
- No markings on the cover, labels are available
- UL-Listed (UL1863), designed to NEMA 3R
- Box weight: 18 lbs.



* Optional brackets for recessed mount

