



BN Products-USA™

A DIVISION OF BENNER-NAWMAN, INC.

WWW.BNPRODUCTS.COM

DC-20WH

Portable Rebar Cutter: Parts Guide

BN Products Customer Service: (800) 992-3833

15 Tons Cutting Pressure | 3 Seconds Cut Time | Up to #6 or 3/4" Grade 60 Rebar

Electric/Hydraulic Rebar Cutter

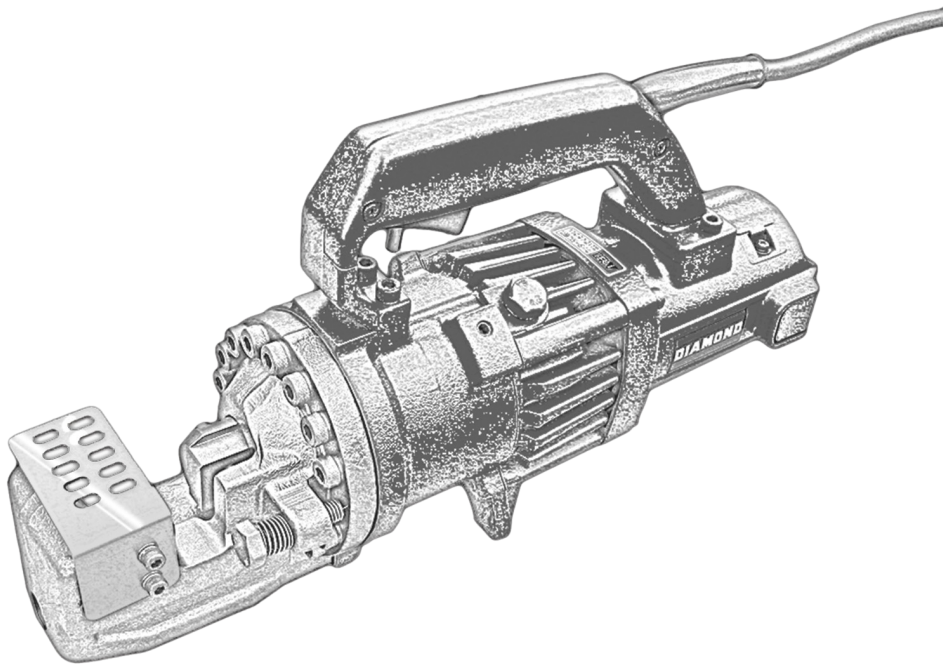

The DC-20WH is a heavy-duty portable, electric-hydraulic rebar cutter. This machine will safely cut rebar up to #6 (3/4") diameter (Grade 60).

The DC-20WH is a spark-free, efficient, cold-cutting shear that includes a safety relief valve for retracting the piston, and a cutting guard as standard features.

The DC-20WH Rebar Cutter kit ships in a carrying case, and includes hydraulic oil and a maintenance tool kit.

Tune-up kits and replacement supplies are sold separately.



Maximum Cutting Diameter	3/4" #6 Rebar (19mm) - Grade 60
Cutting Speed / Pressure	3 Seconds / 15 Tons
Voltage/Amperage	115V 50/60Hz / 10 amps
Tool Weight	25.4 lbs (11.5 kg)
Dimensions L x W x H	16" (410mm) x 4.3" (110mm) x 8.2" (210mm)
CSA Certified	Yes
ETL Listed	Yes

BN Products-USA™

3450 N. Sabin Brown Road | Wickenburg, AZ 85390

(800) 992-3833 | www.BNProducts.com

**PRODUCT
PARTS GUIDE**

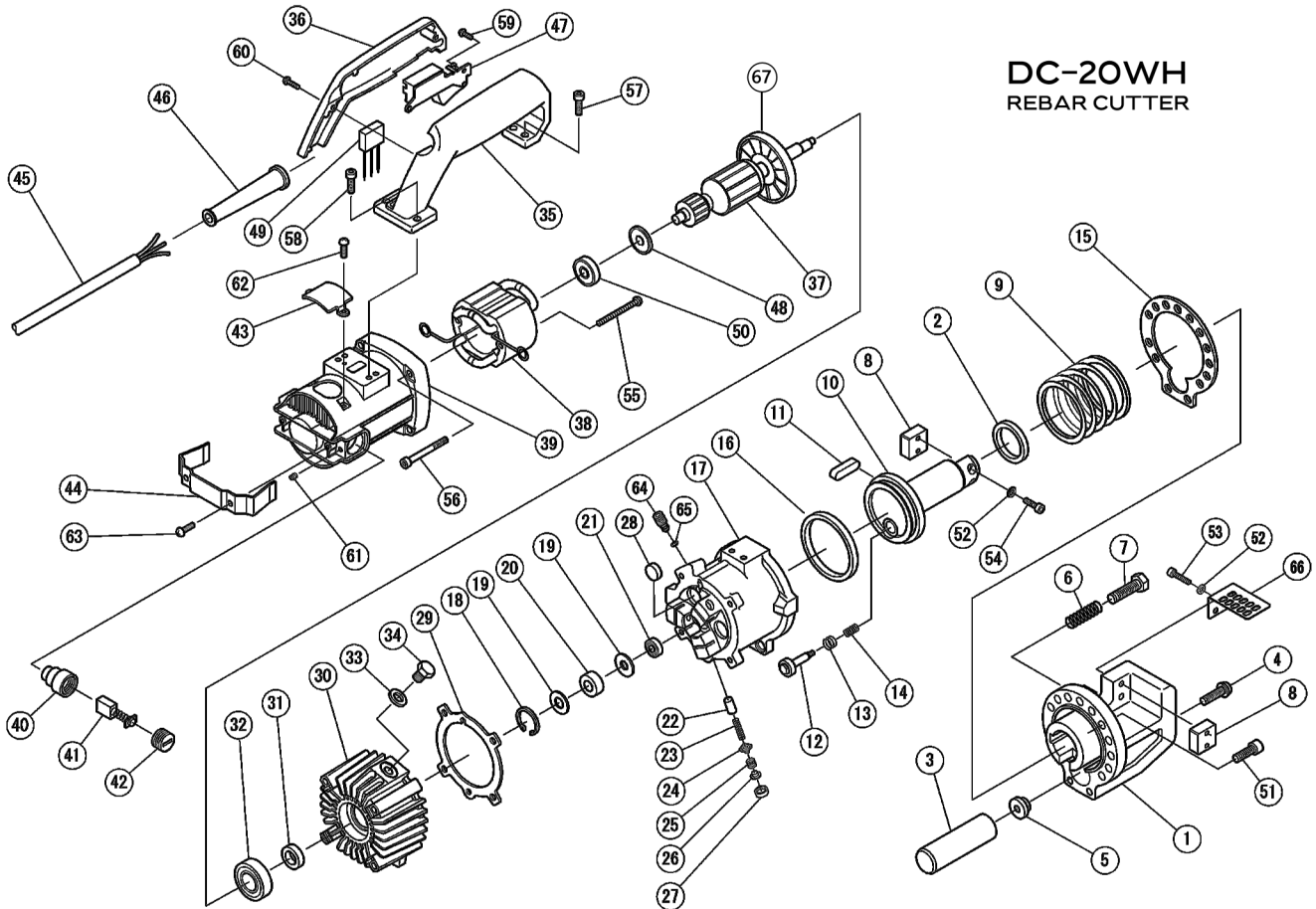

DC-20WH - Maintenance Parts Available

Maintenance parts and and replaceable components are available though BN Products-USA™ Distributors.

If assistance is required, please contact BN Products-USA™ Customer Service at (800) 992-3833.

Product Number	Description
• RB-20XH	Cutting Blocks - Set of two for DC-20WH
• RB-20WH/75	Cutting Blocks - Set of two "Grade 75" for DC-20WH
• TU20K	Tune-Up Kit - DC-20XH & DC-20WH
• BN7356	Hydraulic Oil (1 Quart)



BN Products-USA™

A DIVISION OF BENNER-NAWMAN, INC.

WWW.BNPRODUCTS.COM

DC-20WH

Portable Rebar Cutter: Parts Guide

BN Products Customer Service: (800) 992-3833

DC-20WH Portable Rebar Cutter Parts List

No.	Old Part No.	New Part No.	Part Name
1	1C2053000	1C2053000	HOUSING
2	1CM2002	74605000	SEAL PACKING SKY35
3	1C1958	1C1958	AIR BAG
4	1CM2028	1CM2028	AIR BAG SET BOLT
5	1CM2027	1CM2027	AIR BAG NUT
6	1C4079400	1C4079400	LOCK SPRING
7	1C4160300	1C4160301	STOPPER BOLT M12
8	1C1311	1C1311	CUTTER BLOCK NO.2
9	1C1920	1C19201	RETURN SPRING
10	1C19171	1C3091900	PISTON
11	1C19362	7K1008035R2H	PISTON KEY
12	1C1319	1C1319	RETURN VALVE
13	1C1921	1C1921	RETURN VALVE SPRING
14	1C1922	1C1922	VALVE END SPRING
15	1CM2025	1C3096300	CYLINDER PACKING
16	1C1918	7FU0897-L0	SEAL PACKING
17	1C2061500	1C2061500	CYLINDER
18	1C1326	7SRH027	SNAP RING H27
19	1C1325	1C1325	BEARING GUIDE
20	1C13401	712NQ2410A	NEEDLE BEARING
21	1CW0003	7698	BALL BEARING 698
22	1C1327	1C1327	RAM
23	1C1330	1C1330	RAM RETURN SPRING
24	1C13281	1C13281	DELIVERY VALVE
25	1C1331	1C1331	DELIVERY VALVE SPRING
26	1C13352	1C13352	SPRING GUIDE
27	1C13292	1C13292	PUMP HEAD SEAL
28	3P1044	3P1044	MAGNET FILTER
29	1C1951G	1C4194300	PUMP CASE PACKING
30	1C2059900	1C2059900	PUMP CASE
31	1C1342	7SC15257	OIL SEAL SC15-25-7
32	1C1941	76004VV	BALL BEARING 6004VV
33	1C1305	7WF10	SEAL WASHER WF10

No.	Old Part No.	New Part No.	Part Name
34	7B10015	7B10015	OIL PLUG M10X15
35	1C2618	1C2618	MAIN HANDLE
36	1C1946	1C1946	SWITCH COVER
37	1C19612E	7HTK360718CB	ARMATURE ASSEMBLY
38	1C1961D	7HTK944535CB	STATOR COIL
39	1C1961K	7HTK971050B	MOTOR HOUSING
40	1C1961J	7HTK971001B	BRUSH HOLDER
41	1C1961A	7HTK999043B	CARBON BRUSH SET
42	1C1961H	7HTK935829B	BRUSH CAP
43	7971055	7HTK971055B	SIDE COVER
44	1C1961S	7HTK971091B	TAIL COVER
45	1C1961F	1C1961F	CORD SET
46	1C1961I	7HTK940778B	CORD ARMOR
47	1C1961B	7HTK971390B	SWITCH
48	7HTK310546B	7HTK310546B	DUST WASHER
49	1CL001N	7HTK308283B	1C1961L CONDENSER
50	760002RU	760002RU	BALL BEARING 6000VV
51	7CB08025	7CB08025	CAP BOLT M8X25
52	7SW005	7SW005	SPRING WASHER M5
53	7CB05025	7CB205025	CAP BOLT M5X25
54	7CB05018	7CB205018	CAP BOLT M5X18
55	7P205055	7P205055	PAN HEAD BOLT M5X55
56	7CB06090	7CB06090	CAP BOLT M6X90
57	7CB06016	7CB06016	CAP BOLT M6X16
58	7CB06018	7CB06018	CAP BOLT M6X18
59	7P204008	7P204008	PAN HEAD BOLT M4X8
60	7PB04015	7P204016	PAN HEAD BOLT M4X16
61	7SS05008	7SS05008	SET SCREW M5X8
62	7P204008	7P204008	PAN HEAD BOLT M4X8
63	7P205010	7P205010	PAN HEAD BOLT M5X10
64	1C4160601	1C4160601	RELEASE VALVE
65	7ORS4	7ORS4	O RING
66	1C4195900	1C4195900	CUTTER GURAD
67	1C1961PF	7HTK971097B	ARMATURE FAN



QUALITY PRODUCTS ENGINEERED WITH INTELLIGENCE AND IMAGINATION

www.BNProducts.com